



# **LIFE CYCLE REPORT**

for

## **DALGUISE HOUSE DEVELOPMENT**

at

**MONKSTOWN  
CO. DUBLIN**

for

**GEDV MONKSTOWN OWNER LIMITED**

issue no.	issue date	pages	issued for	by	approvals	
					checked	approved
01	03/11/2022	21	Planning	ST	SC	MR

---

## **CONTENTS**

---

<b>SECTION 1</b>	<b>INTRODUCTION</b>
<b>SECTION 2</b>	<b>PLANNING GUIDELINES 28 - LIFE CYCLE REPORT REQUIREMENTS</b>
<b>SECTION 3</b>	<b>DESCRIPTION OF THE ENERGY STRATEGY</b>
<b>SECTION 4</b>	<b>BUILDING MANAGEMENT SYSTEM</b>
<b>SECTION 5</b>	<b>RECOMMENDED MAINTENANCE SCHEDULES</b>
<b>SECTION 6</b>	<b>ESTIMATED PLANT LIFESPAN</b>
<b>SECTION 7</b>	<b>BUILDING FAÇADE</b>
<b>APPENDIX A</b>	<b>DOMESTIC FUEL COSTS</b>

## 1.0 INTRODUCTION

This report was compiled by METEC Consulting Engineers on behalf of the applicant, GEDV Monkstown Owner Limited, as part of the planning submission for the proposed Dalguise House development at Dalguise House, Monkstown, Co. Dublin.

This report deals specifically with the topic of Operation and Management of Apartment Developments as outlined in the new Planning Guidelines [28], Sustainable Urban Housing: Design Standards for new Apartments, Guidelines for Planning Authorities (2020).

This report describes the following;

- Context to the Planning Guidelines
- Description of the proposed energy strategy
- Estimated annual running costs
- Building Management System (BMS)
- Recommended maintenance schedules
- Estimated mechanical plant lifespan
- Building Façades design principle

## 2.0 PLANNING GUIDELINES 28 - LIFE CYCLE REPORT REQUIREMENTS

This report responds to the Planning Guidelines [28], Sustainable Urban Housing: Design Standards for new Apartments, Guidelines for Planning Authorities, in particular to the Operation and Management of Apartment Developments.

These guidelines state the following;

*"6.11 Certainty regarding the long-term management and maintenance structures that are put in place for an apartment scheme is a critical aspect of this form of residential development. It is essential that robust legal and financial arrangements are provided to ensure that an apartment development is properly managed, with effective and appropriately resourced maintenance and operational regimes.*

*6.12 In this regard, consideration of the long-term running costs and the eventual manner of compliance of the proposal with the Multi- Unit Developments Act, 2011 are matters which should be considered as part of any assessment of a proposed apartment development.*

*6.13 Accordingly, planning applications for apartment development shall include a building lifecycle report which in turn includes an assessment of long-term running and maintenance costs as they would apply on a per residential unit basis at the time of application, as well as demonstrating what measures have been specifically considered by the proposer to effectively manage and reduce costs for the benefit of residents."*

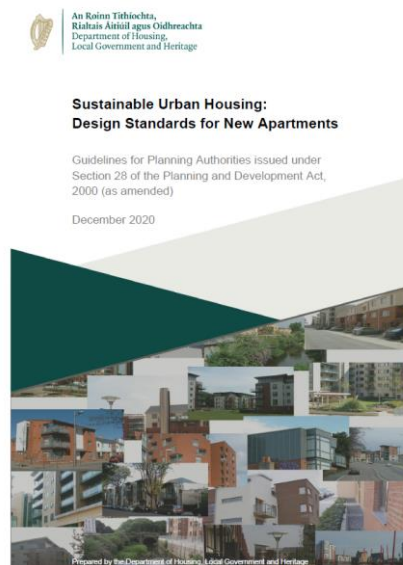

Planning Guidelines [28], Sustainable Urban Housing: Design Standards for new Apartments, Guidelines for Planning Authorities.

### **3.0 DESCRIPTION OF THE ENERGY STRATEGY**

#### **INTRODUCTION**

Listed below are the design options being considered for the energy strategy of the proposed. Several options are being considered, all of which would comply with Part L of the Building Regulations and provide a similar Primary Energy Demand. As each of the considered options are those of energy efficient design, there is no notable difference between them in terms of Environmental Impact, and one will be selected during the detailed design stage based on thermal modelling and market conditions.

Additional measures are also being considered to ensure the energy efficiency of the proposed development. These measures include all LED light fittings and White Goods which meet the suggested energy ratings shown below:

- Oven – A+
- Fridge/Freezer – A+
- Dishwasher – AAA
- Washer/Dryer – B

Due to the proposed development being that of a multi-unit nature with a variety of common areas, compliance with the Multi-Unit Development Act 2011 is considered to be a high priority among the developmental considerations for this project. Such considerations include the intended contractual establishment and maintenance of an Owner's Management Company which will be responsible for the care and maintenance of all rights and amenities available to building occupants.

## OPTION 1: Exhaust Air Heat Pumps

An energy strategy for this development is to design individual apartment heating systems using an Exhaust Air Heat Pump as the heat generator.

Exhaust Air Heat Pumps (EAHP) use a Vapour Compression (Refrigeration) cycle with a mixture of high temperature air from the apartment extract system and outside air to produce high grade heat suitable for space heating and hot water production. No additional ventilation system is then required. The higher temperature air passing through the evaporator results in high efficiency and low running costs. Modern Exhaust Air heat pump systems can be used in applications where there is a significant year-round demand for heating and hot water and have the advantages of not requiring any fossil fuels to be stored or distributed. This can bring significant air quality benefits to the surrounding areas. An added advantage is that there is no outdoor unit to be located, all mechanical parts are within the apartment in a single 600mm x 600mm casing.

The heat emitted from the Heat Pump is used to provide space heating and domestic hot water. Modern Exhaust Air Heat Pumps use a variable speed drive type compressor and have load and weather compensation system build in as standard ensuring maximum efficiency is achieved and running costs are minimised. It is worth noting that electricity in Ireland (as of 2020) has a Primary Energy (PE) factor of 1.83 (1.83 energy units per kWh delivered). Most Exhaust Air heat pumps have a coefficient of performance (COP) exceeding 4.00 Therefore the difference between the COP and the PE factor can be considered renewable i.e.

$$\begin{aligned} \text{Renewable Contribution} &= \text{COP} - \text{PE Factor} \\ &= 4.00 - 1.83 \\ &= \mathbf{2.17} \end{aligned}$$

These residential units have a predictable year-round demand for hot water, this makes Exhaust Air heat pumps a potentially suitable technology for the development. At the detailed design stage, the thermal & electrical load profiles will be analysed using a thermal dynamic simulation model which will use building occupancy profiles and real weather data. Each individual Heat Pump would then be sized to suit the demand & load profile of each unit. The diagrammatic image on the next page shows how a typical Exhaust Air Heat Pump (i.e. NIBE) would be integrated into each unit:

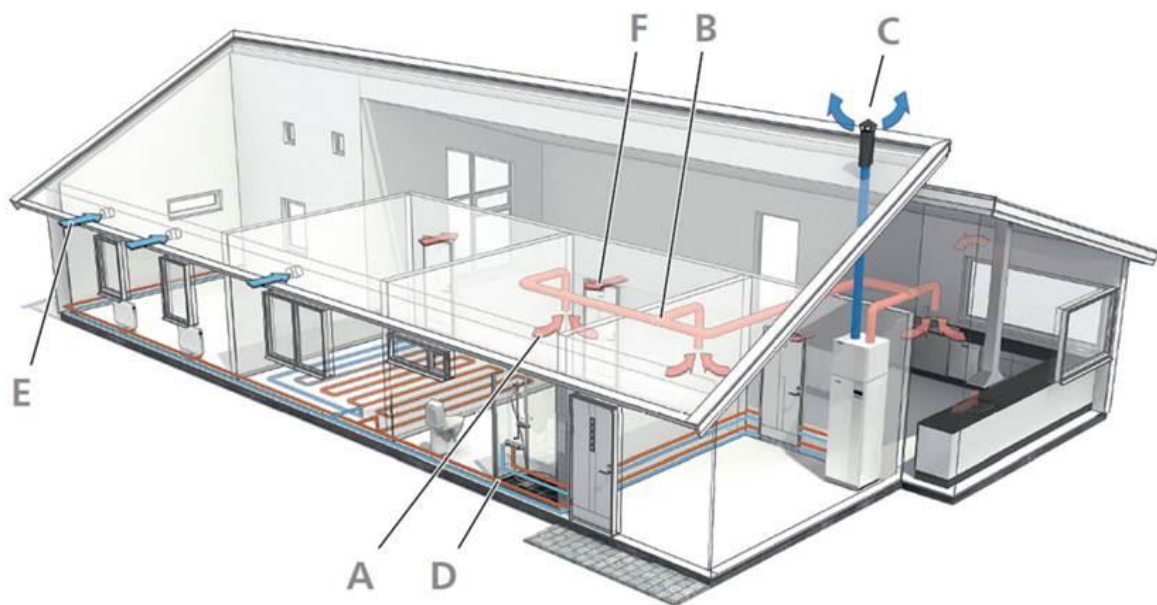

*Figure 1: A) The warm air is drawn into the air duct system. B) The warm air is fed to Nibe. C) The room air is released when it has passed Nibe. The air temperature has then been reduced as Nibe has extracted the energy in the room air. D) Nibe supplies the house with hot water and room heating. E) Outdoor air is drawn into the house. F) Air is transported from rooms with outdoor air devices to rooms with exhaust air valves.*

Figure 3.0.1 Typical Exhaust Air Heat Pump System (Space Heating emitters can be Radiators or Underfloor Heating or a mixture of both)



## OPTION 2: Air to Water Heat Pumps

Another option being considered for the energy strategy for this development is to design individual apartment heating systems using an Air to Water Heat Pump as the heat generator.

Air to Water Heat Pumps, also known as Air Source Heat Pumps (ASHP), use the same Vapour Compression (Refrigeration) cycle as the Exhaust Air Heat Pumps detailed above but use low grade heat from the outside and convert this heat to high grade heat suitable for space heating and hot water production. Air to Water systems can be used in applications where there is a significant year-round demand for heating and hot water and have the added advantages of not requiring any fossil fuels to be stored or distributed. This can bring significant air quality benefits to the surrounding areas.

An Air to Water unit comprises of an outdoor unit which contains the evaporator and compressor and an internal unit containing Hot Water storage and controls for space heating and hot water. The compressor increases the refrigerant pressure which proportionally increases the refrigerant temperature. The refrigerant also changes phase from vapour to liquid. Heat is then transferred to the space heating and hot water cylinder reducing the temperature of the now liquid refrigerant. The refrigerant then goes through a rapid reduction in pressure and a proportional drop in temperature at the expansion valve. A change in phase from liquid to vapour also occurs. The now extremely cold low-pressure refrigerant passes through the evaporator where it picks up low grade heat from the outside air where its pressure and temperature increase proportionally. The refrigerant now re-enters the compressor and the cycle repeats perpetually. The system is closed and the refrigerant does not need replacement except in the very rare event of a leak. As the refrigerant in modern heat pumps are both non-toxic and do not contribute to Global Warming, leaks are not a major concern.

The heat emitted from the Heat Pump is used to provide space heating and domestic hot water. Modern Heat Pumps use a variable speed drive type compressor and have load and weather compensation system build in as standard ensuring maximum efficiency is achieved and running costs are minimised. It is worth noting that electricity in Ireland (as of 2020) has a Primary Energy (PE) factor of 1.83 (1.83 energy units per kWh delivered). Most Air to Water heat pumps have a coefficient of performance (COP) exceeding 4.00 Therefore the difference between the COP and the PE factor can be considered renewable i.e.

$$\begin{aligned} \text{Renewable Contribution} &= \text{COP} - \text{PE Factor} \\ &= 4.00 - 1.83 \\ &= \mathbf{2.17} \end{aligned}$$

These residential units have a predictable year-round demand for hot water, this makes air to Water a potentially suitable technology for the development. At the detailed design stage, the thermal & electrical load profiles will be analysed using a thermal dynamic simulation model which will use building occupancy profiles and real weather data. Each individual Heat Pump would then be sized to suit the demand & load profile of each unit. The diagrammatic image on the next page shows how a typical Heat Pump (i.e. Daikin) would be integrated into each unit:

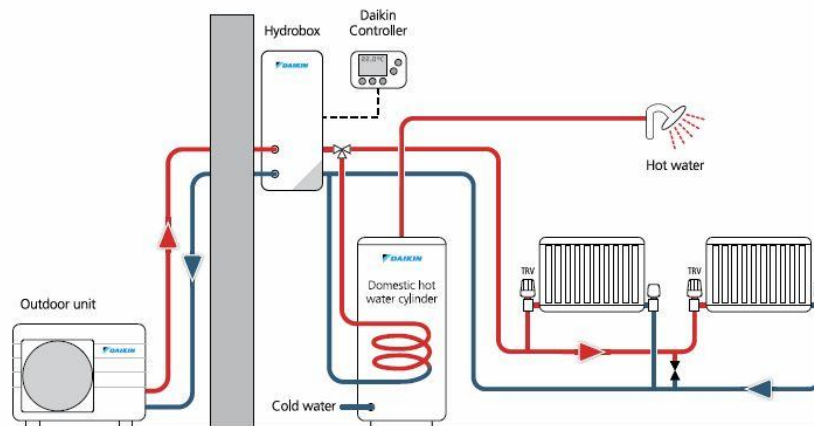

Figure 3.0.2 Typical Daikin Air to Water Heat Pump System (Space Heating emitters can be Radiators or Underfloor Heating or a mixture of both)

### OPTION 3: Combined Heat & Power with Gas Fired Condensing Boilers

One option being considered for the energy strategy for this development is to design a district heating system using centrally located Combined Heat and Power (CHP) and gas fired condensing boilers.

Combined heat and power (CHP), also known as co-generation, is the simultaneous generation of both useable heat and electrical power from the same source. CHP systems can be used in applications where there is a significant year-round demand for heating and hot water in addition to the electricity generated.

A CHP unit comprises of an engine (referred to as the prime mover) in which fuel is combusted. The mechanical power produced by the engine is used to generate electricity using an integral electrical generator. The heat emitted from the engine (waste heat) is used to provide space heating and domestic hot water. In order for CHP engines to be economic they must run for between 4,500 and 5,000 hours per annum therefore are usually sized on or below the base loads.

These residential units have a predictable year-round demand for hot water, this makes CHP a potentially suitable technology for the development. At the detailed design stage, the thermal & electrical load profiles will be analysed using a thermal dynamic simulation model which will use building occupancy profiles and real weather data. The CHP would operate as the "Lead Boiler" providing space heating and domestic hot water to heat interface units (HIU) in each apartment. The diagrammatic image on the next page shows how a CHP complete with Heat Interface Units shall be integrated into a district heating scheme.

Due to this options reliance on gas, it does present potential financial and sourcing difficulties given the current issues associated with this fuel source.

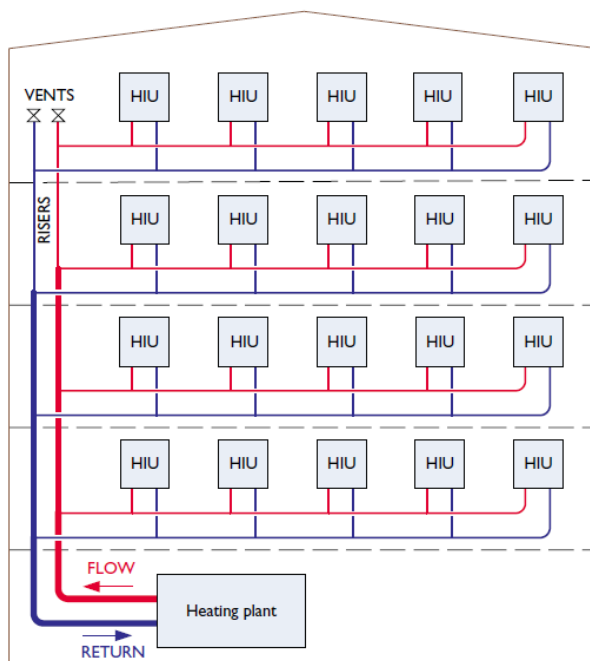
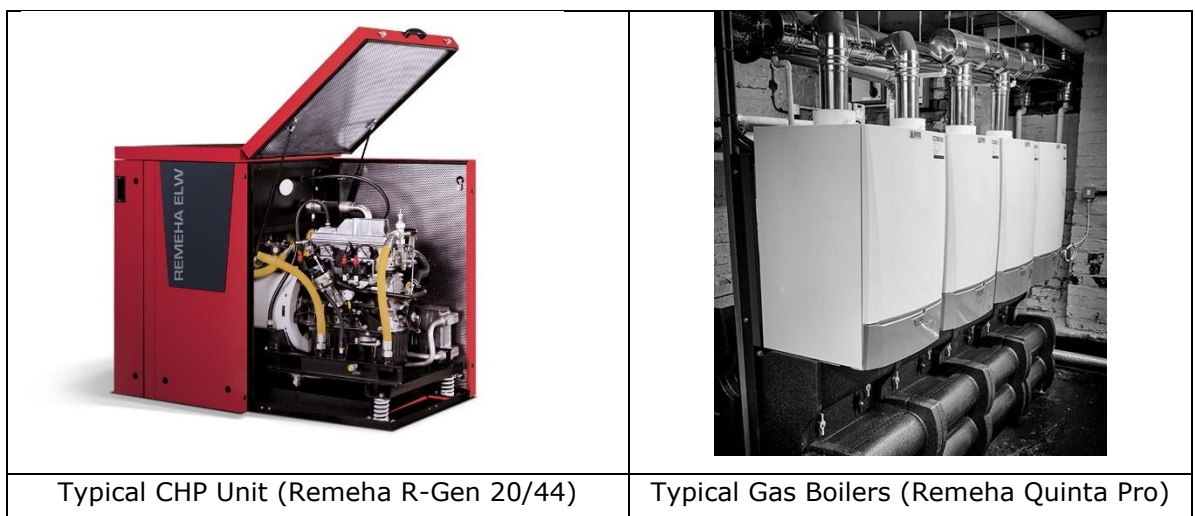
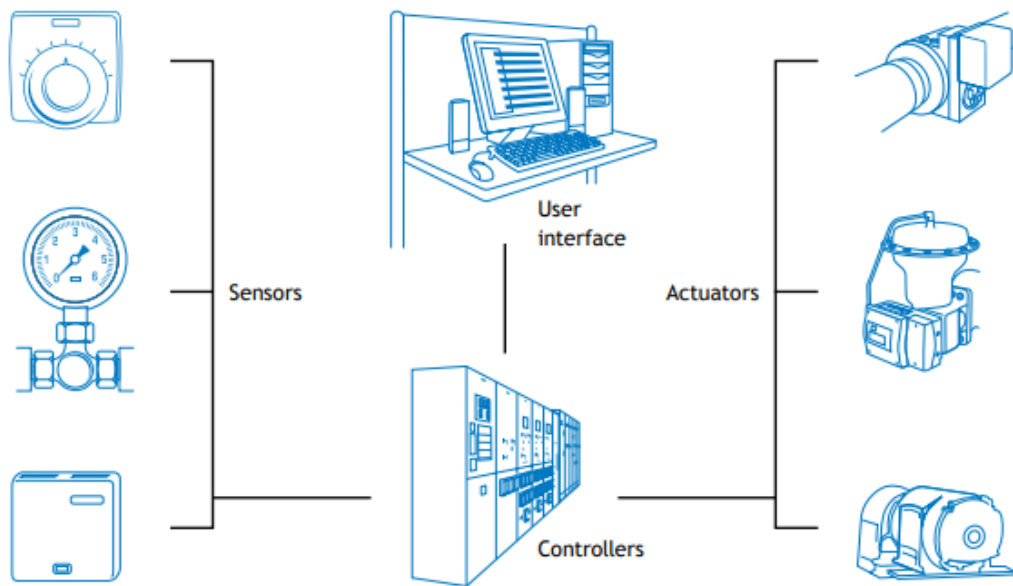





Figure 3.0.3 Diagrammatic image illustrating an Apartment block with district heating using Heat Interface Units.

#### 4.0 BUILDING MANAGEMENT SYSTEM (APPLIES TO CHP BASED SYSTEM ONLY)

In order to ensure optimum energy efficiency and comfort levels for the design of the Mechanical and Electrical systems a Building Energy Management System (BEMS) shall be specified. A BEMS is a computer-based system which provides the facility to control any building service. Intelligent controllers, or 'outstations' monitor conditions throughout the building and determine the operation of boilers, pumps, fans, motors and lighting in response to changing conditions such as time, temperature and light levels. Training will be provided to the Owners Management Company (OMC) and maintenance personnel to ensure the correct operation of the system.



Submetering will also be included within the Mechanical and Electrical systems design for this project. Installing submetering to measure selected areas of energy use will give a considerably better understanding of where energy is used and where there may be scope to make savings.

		
<p>Belimo Energy Valves</p>	<p>3 Phase Power Meter</p>	<p>Pulsed Output Water Meter</p>

## 5.0 RECOMMENDED MAINTENANCE SCHEDULES

The Applicant and the project design team have fully considered the long-term running and maintenance costs associated with the proposed apartment scheme. In considering various energy strategies for this development, a central district heating system has been deemed the preferred option, largely due to the fact that plant maintenance for the most part can be scheduled centrally within the landlord plant areas. This approach ensures that effective and appropriately resourced maintenance and operational regimes can be carried out with minimal disruption to individual tenants.

### OPTION 1: Exhaust Air Heat Pump Service Schedule (Located in each apartment)

Typical service plan rates for Exhaust Air Heat Pumps are approximately €200 per heat pump unit per year. By their design and very nature, maintenance requirements are very low. An annual check is often all this is required to ensure optimum system operation.

At the time of writing this report the long-term running costs associated with this system are approximately €800 per annum. Please see Appendix A for information regarding current domestic fuel costs.

A Wi-Fi adapter can be fitted to most heat pumps to notify any faults remotely to the heat pump supplier. Apartment occupants are not expected to carry out any maintenance. Modern heat pumps are very reliable systems and when designed and installed correctly, have a very long lifespan.

Unit	Service Interval
Exhaust Air Heat Pump	<p>Exhaust Air Heat Pumps are inherently low-maintenance space heating systems. A maintenance check every year is sufficient unless otherwise advised by the manufacturer.</p> <p>In general, maintenance requirements are similar to that of a typical gas or oil boiler. Very little user input is required.</p> <p>Inspection and maintenance procedures for the heat pump should follow manufacturer’s guidance and include at least the following:</p> <ul style="list-style-type: none"> <li>• Clean fan unit and ensure airflow path is clear.</li> <li>• Anti-Freeze level check and top up if necessary.</li> <li>• Internal strainer &amp; filter cleaning</li> <li>• Removal of any trapped air</li> </ul>

	<ul style="list-style-type: none"> <li>• Check system pressure &amp; flow rate is correct</li> <li>• Check Circulating pump is operating correctly</li> <li>• Control valves must respond to demand signals for heating and hot water</li> <li>• Check Expansion Vessel charge</li> <li>• Supply temperatures to heating and hot water as commissioned</li> <li>• Check safety valve (where fitted)</li> <li>• Check Immersion Heater</li> <li>• Clean each extract valve.</li> <li>• Check outdoor air damper and confirm correct operation.</li> <li>• Check ducting and confirm condition</li> <li>• Complete Maintenance Report</li> <li>• Consumer satisfied with heating and hot water performance</li> </ul>
--	---

**OPTION 2: Air to Water Heat Pump Service Schedule (Located in each apartment)**

Typical service plan rates for Air to Water Heat Pumps are approximately €200 per heat pump unit per year. By their design and very nature, maintenance requirements are very low. An annual check is often all this is required to ensure optimum system operation.

At the time of writing this report the long-term running costs associated with this system are approximately €734 per annum. Please see Appendix A for information regarding current domestic fuel costs.

A Wi-Fi adapter can be fitted to most heat pumps to notify any faults remotely to the heat pump supplier. Apartment occupants are not expected to carry out any maintenance. Modern heat pumps are very reliable systems and when designed and installed correctly, have a very long lifespan.

Unit	Service Interval
Air to Water Heat Pump – Indoor & Outdoor Unit	<p>Air to Water Heat Pumps are inherently low-maintenance space heating systems. A maintenance check every year is sufficient unless otherwise advised by the manufacturer.</p> <p>In general, maintenance requirements are similar to that of a typical gas or oil boiler. Very little user input is required.</p> <p>Inspection and maintenance procedures for the heat pump should follow manufacturer’s guidance and include at least the following:</p>

	<ul style="list-style-type: none"> <li>• Clean outdoor unit and ensure airflow path is clear.</li> <li>• Anti-Freeze level check and top up if necessary.</li> <li>• Internal strainer &amp; filter cleaning</li> <li>• Removal of any trapped air</li> <li>• Check system pressure &amp; flow rate is correct</li> <li>• Check Circulating pump is operating correctly</li> <li>• Control valves must respond to demand signals for heating and hot water</li> <li>• Check Expansion Vessel charge</li> <li>• Supply temperatures to heating and hot water as commissioned</li> <li>• Check safety valve (where fitted)</li> <li>• Check Immersion Heater</li> <li>• Complete Maintenance Report</li> <li>• Consumer satisfied with heating and hot water performance</li> </ul>
--	---

**OPTION 3: CHP Recommended Service Schedule (Located Centrally with Landlord Plant Area).**

An assessment of the long-term running and maintenance requirements which apply to both landlord central plant and equipment installed in each residential unit has been carried out and can be summarised as follow. Typical service plan rates for CHP engines typically equate to €0.78 per hour run.

At the time of writing this report the long-term running costs associated with this system are approximately €535 per annum. Please see Appendix A for information regarding current domestic fuel costs.

<b>Combined Heat &amp; Power Unit (Centrally located Landlord System)</b>		
<b>Unit</b>	<b>Service Interval</b>	<b>Maintenance Level</b>
Combined Heat & Power Unit	6,000 Operating Hours	M1
	12,000 Operating Hours	M1
	18,000 Operating Hours	M2
	24,000 Operating Hours	M1
	30,000 Operating Hours	M3
	36,000 Operating Hours	M1
	42,000 Operating Hours	M1
	48,000 Operating Hours	M2
	54,000 Operating Hours	M1
	60,000 Operating Hours	M3

<b>CHP Maintenance Operation</b>	<b>M1</b>	<b>M2</b>	<b>M3</b>
Customer instruction and operating log check completed	X	X	X
Pressures and temperatures checked for plausibility	X	X	X
Start-up process checked	X	X	X
Start/stop behaviour checked	X	X	X
All work documented in the operating log / assembly log	X	X	X
Original mode of operation re-established	X	X	X
System and installation room cleaned	X	X	X
<b>Lubricant</b>	<b>M1</b>	<b>M2</b>	<b>M3</b>
Oil and filter change performed	X	X	
Engine oil level checked	X	X	X
Engine oil refilled	B	B	B

<b>Engine Mechanics</b>	<b>M1</b>	<b>M2</b>	<b>M3</b>
Rocker arms and bearings checked	X	X	
Engine generator (Genset) replaced			X

<b>Engine Mechanics</b>	<b>M1</b>	<b>M2</b>	<b>M3</b>
Spark plug sockets inspected	X	X	X
Spark plugs replaced	X	X	
Spark plug extender o-ring replaced	X	X	
Ignition timing checked	X	X	
Ignition timing adjusted			X
Speed sensor, including seal, replaced		X	
Seal for speed sensor replaced	X		
Cam shaft sensor, including seal, replaced		X	
Seal for cam shaft sensor replaced	X		

<b>Electrics</b>	<b>M1</b>	<b>M2</b>	<b>M3</b>
Generator terminals at the soft starter / frequency converter checked and tightened	X	X	X
Emergency stop switch: Function test carried out	X	X	X
Gas low pressure switch: Function test carried out (only if installed)	X	X	X
Wiring harness replaced			X
Main switch: Function	X	X	X

<b>Exhaust system / Catalyst</b>	<b>M1</b>	<b>M2</b>	<b>M3</b>
Exhaust gas line checked for fastening and tightness	X	X	X
Condensate drains (neutralisation) checked and cleaned	X	X	X
Condensate drains (water trap / siphon) checked, cleaned and if necessary filled	X	X	X
Emissions measurement carried out, cat, replaced if necessary (if there are two gas)	X	X	X



Lambda sensor replaced (only for not turbocharged engines)		X	
Exhaust gas hoses (internal) replaced		X	

Filter Elements	M1	M2	M3
Supply air filter replaced (if installed)	X	X	X
Intake air filter housing and cooling chamber cleaned including heat exchanger	X	X	X
Air filter replaced	X	X	X
Filter inserts in the control cabinet, load control cabinet, sub-distribution cabinet replaced	X	X	X
Crankcase ventilation filter replaced (other modules)	X	X	

Maintenance Operation	M1	M2	M3
<b>P&amp;ID System</b>			
Coolant level / pressure and content checked	X	X	X
Coolant refilled	B	B	
Coolant replaced			X
Gas multiblock adjusted	X	X	X
All gas shutoff valves: Function test carried out	X	X	X
Machines Feet inspected	X	X	
Machine Feet replaced			X
Gas mixture system: Leak test carried out with detecting spray	X	X	X
Expansion tank checked for function and pre-pressure (engine circuit / heating circuit)	X	X	X
Engine circuit: Coolant hoses, including clamps, replaced			X
Heating circuit: Coolant hoses, including clamps, replaced			X
Hoses, oil-proof, HT, including clamps, replaced (oil)		X	
Pipe clamps with rubber insert replaced		X	X
Mounting base (wiring harness) replaced			X
Sludge trap cleaned (if available)	X	X	X

Boilers - Recommended Service Schedule (Located Centrally with Landlord Plant Area).

Unit	Service Interval
Boilers	Annual boiler service based on running hours of 8 hours per day

Mechanical Ventilation Heat Recovery Unit Recommended Service Schedule (Located within the individual apartments).

Unit	Service Interval
Mechanical Ventilation Heat Recovery Units (MVHR)	Clean filters every 3-6 months (Vacuum only) Replace filters every year

Heat Interface Units Recommended Service Schedule (Located within the individual apartments).

Unit	Service Interval
Heat Interface Units (HIU)	<p>HIUs are inherently low-maintenance space heating systems. A maintenance check every 3 years should be sufficient unless otherwise advised by the manufacturer.</p> <p>Inspection and maintenance procedures for the HIU should follow manufacturer's guidance and include at least the following:</p> <ul style="list-style-type: none"> <li>• No leaks associated with HIU or secondary distribution</li> <li>• Primary isolation valves operable</li> <li>• Internal strainer clear</li> <li>• Supply differential pressure above required minimum</li> <li>• Thermal insulation intact</li> <li>• Secondary system pressurisation in nominal range</li> <li>• Control valves respond to demand signals for heating and hot water</li> <li>• Secondary pumps functional</li> <li>• Supply temperatures to heating and hot water as commissioned</li> <li>• Check mains pressure storage water heater safety valve (where fitted)</li> <li>• Heat meter registers demand (or replace and commission new heat meter if scheduled)</li> <li>• Secondary system water treatment replenished</li> <li>• Consumer satisfied with heating and hot water performance</li> </ul>

Building Energy Management System Recommended Service Schedule (Located Centrally within Landlord Area).

Unit	Service Interval
Building Energy Management System (BEMS)	Annual inspection/calibration visit from BEMS supplier

## 6.0 ESTIMATED PLANT LIFESPAN

<b>Exhaust Air Heat Pump</b>		
Lifespan	Key maintenance Requirements to improve the lifespan	End of life, Parts that can be recycled
15-20 Years	Annual Service	All of the parts can be recycled with the oil and refrigerant being removed prior to disposal.

<b>Boilers</b>		
Lifespan	Key maintenance Requirements to improve the lifespan	End of life, Parts that can be recycled
12-15 Years	Annual Service (based on an 8 hour a day)	All parts of the boilers can be recycled.

<b>Air to Water Heat Pump</b>		
Lifespan	Key maintenance Requirements to improve the lifespan	End of life, Parts that can be recycled
15-20 Years	Annual Service	All of the parts can be recycled with the oil and refrigerant being removed prior to disposal.

<b>CHP</b>		
Lifespan	Key maintenance Requirements to improve the lifespan	End of life, Parts that can be recycled
15-20 Years	Replace the Genset after 30,000 (usually included in the service plan)	All of the parts can be recycled with the oil and coolant being removed prior to disposal.

## 7.0 BUILDING FAÇADE

The design of the building façade has been such that consideration has been given to reducing the running and maintenance costs of the residential units through the specification of the following:

- The proposed development will meet or exceed the requirements of the current building regulations, see Figure 7.0.1 below, in terms of thermal performance, thus ensuring that heating energy consumption is considerably reduced at source.
- The glazing specification of the proposed development will be such that the useful benefit of light transmittance and solar gain are all carefully balanced to ensure that the specification is optimal. A high level of light transmission will allow daylight to internal spaces to be maximised thus reducing reliance on electric lighting systems, similarly utilising solar gain during the winter months when the sun's path is low will provide a passive heating source to the dwellings.
- External brickwork and rendering systems will be such that regular maintenance shall not be required.

Table 1 Maximum Elemental U-value <sup>1</sup> (W/m <sup>2</sup> K)		
Column 1 Fabric Elements	Column 2 Area Weighted Average Elemental U-Value (U <sub>a</sub> )	Column 3 Average Elemental U-value Individual Element or Section of Element
Roofs <sup>2</sup>		
Pitched roof		
- Insulation at ceiling	0.16	0.3
- Insulation on slope	0.16	
Flat roof	0.20	
Walls <sup>2</sup>	0.21	0.6
Ground Floors <sup>2,3</sup>	0.21	0.6
Other exposed floors <sup>2</sup>	0.21	0.6
External personnel doors, windows <sup>4</sup> and rooflights <sup>6</sup>	1.6 <sup>5</sup>	3.0
Curtain Walling	1.8	3.0
Vehicle access and similar large doors	1.5	3.0
High usage entrance door <sup>7</sup>	3.0	3.0
Swimming Pool Basin <sup>8</sup>	0.25	0.6
Notes:		
1. The U-value includes the effect of unheated voids or other spaces.		
2. Reasonable provision would also be achieved if the total heat loss through the roof, wall and floor elements did not exceed that which would be the case if each of the area weighted average U-value (U <sub>a</sub> ) for these elements set out in Column 2 were achieved individually.		
3. Where the source of space heating is underfloor heating, a floor U-value of 0.15 W/m <sup>2</sup> K should generally be satisfactory.		
4. Excludes display windows and similar glazing but their impact on overall performance must be taken into account in EPC and CPC calculation.		
5. In buildings with high internal heat gains a less demanding area-weighted average U-Value for the glazing may be an appropriate way of reducing overall primary energy and CO <sub>2</sub> emissions. Where this can be shown then the average U-value for windows can be relaxed from the values given above. However values should be no worse than 2.2 W/m <sup>2</sup> K.		
6. This is the overall U-value including the frame and edge effects, and it relates to the performance of the unit in the vertical plane so, for roof-lights, it must be adjusted for the slope of the roof as described in Section 11.1 of BR 443.		
7. High Usage Entrance door means a door to an entrance primarily for the use of people that is expected to experience larger volumes of traffic, and where robustness and/or powered operation is the main performance requirement. To qualify as a high-usage entrance door the door should be equipped with automatic closers and except where operational requirements preclude it, be protected by a lobby.		
8. Where a swimming pool is constructed as part of a new building, reasonable provision should be made to limit heat loss from the pool basin by achieving a U-value no worse than 0.25 W/m <sup>2</sup> K as calculated according to BS EN 13370.		

Figure 7.0.1 Part L 2021 (Dwellings) Maximum Elemental U-values.

**APPENDIX A DOMESTIC FUEL COSTS**

**Domestic Fuels**  
Comparison of Useful Energy Costs for Space Heating

1-Jul-2022

Fuel <sup>19</sup>	Form	Delivered Energy Cost <sup>11</sup> (c/kWh)	Seasonal Efficiency Ratings <sup>18</sup>								Typical Seasonal Efficiencies <sup>28</sup>	
			100%	90%	80%	70%	60%	50%	40%	30%		20%
Peat	Briquettes, Baled	9.51					15.85	19.01	23.77	31.69	47.54	Open Fire, Solid fuel or Gas DFE <sup>22</sup> All 20-30%
Coal	Nuggets (Lignite)	n/a										Open Fire - Designed to Maximise Heating <sup>23</sup> Coal up to 32% Ovoids (Low Smoke) up to 37%
	Premium Coal, bulk	n/a										
	Premium Coal, bag	8.75			10.94	12.50	14.58	17.50	21.87	29.17	43.75	
	Standard Coal, bulk	n/a										
	Standard Coal, bag	8.40			10.50	12.00	14.00	16.80	21.00	28.00	42.00	
	Standard Anthracite <sup>19</sup>	n/a										
	Grade A Anthracite <sup>19</sup>	n/a										
Oil	Ovoids (Low Smoke), bulk <sup>19</sup>	n/a										Open Fire with High Output Back Boiler All 40-50%
	Ovoids (Low Smoke), bag <sup>19</sup>	8.80			10.99	12.57	14.66	17.59	21.99	29.32	43.98	
	Gas Oil (schedule)	15.57		17.30	19.46	22.24	25.94	31.13				Stove / Closed Room Heater (without Back Boiler) Peat 45-55% Coal 50-80% Gas 60-75%
	Gas Oil (typical discounted price)	14.29		15.88	17.86	20.41	23.82	28.58				
L.P.G.	Kerosene (schedule) <sup>20</sup>	15.49		17.22	19.37	22.13	25.82	30.99				Stove / Closed Room Heater (with Back Boiler) All 65-85%
	Kerosene (typical discounted price) <sup>20</sup>	14.26		15.84	17.82	20.36	23.76	28.51				
Wood	Bulk L.P.G. <sup>21</sup>	15.00		16.67	18.75	21.43	25.00	30.01				Oil Fired Boiler Gas Oil 55-75% Kerosene 60-75%
	Bottled Butane	22.30		24.78	27.88	31.86	37.17	44.61				
	Bottled Propane 34kg	24.28		26.98	30.35	34.68	40.46	48.56				Gas Fired Boiler All 55-75%
	Bottled Propane 47kg	24.21		26.90	30.26	34.59	40.35	48.42				
Wood	Pellets Bulk Delivery	8.80		9.77	10.99	12.57	14.66	17.59	21.99			Wood Product or Biomass Boiler All 55-87%
	Pellets Bagged	0.00		-	-	-	-	-	-			
	Briquettes	15.57		17.30	19.46	22.24	25.94	31.13	38.92	51.89	77.83	
	Hardwood, Small Bag, 20% moisture, Collected	15.49			n/a	n/a	n/a	n/a	n/a	n/a	n/a	
	Softwood, Small Bag, 25% moisture, Collected	14.26			17.82	20.36	23.76	28.51	35.64	47.52	71.28	
	Hardwood, Full Pallet, 20% moisture, Delivered	0.00			-	-	-	-	-	-	-	
	Softwood, Full Pallet, 25% moisture, Delivered	15.00			18.75	21.43	25.00	30.01	37.51	50.01	75.01	
Natural Gas	Softwood, Bulk (loose), 25% moisture, Delivered	22.30			27.88	31.86	37.17	44.61	55.76	74.34	111.51	Flueless Gas <sup>24</sup> All 90%
	Band D1: <5,556 kWh per annum	10.00		11.11	12.50	14.29	16.67	20.00	25.00	33.34	50.01	
	Band D2: >=5,556 <55,556 kWh per annum	7.83		8.70	9.78	11.18	13.05	15.66	19.57	26.09	39.14	
Electricity	Band D3: >=55,556 kWh per annum	7.52		8.35	9.40	10.74	12.53	15.04	18.80	25.06	37.59	Condensing Boiler 85-97%
	Band DA: <1,000 kWh per annum	42.12	42.12	46.80								
	Band DB: >=1,000 <2,500 kWh per annum	37.99	37.99	42.21								Electric Storage Heater All 90%
	Band DC: >=2,500 <5,000 kWh per annum	29.74	29.74	33.05								
	Band DD: >=5,000 <15,000 kWh per annum	25.34	25.34	28.15								
Band DE: >=15,000 kWh per annum	20.83	20.83	23.14								Electric (Electric Fire, Panel Heater) All 100%	
Night rate	11.54	11.54	12.82									